

---

## **An intuitive approach to innovate a low cost Braille embosser**

---

Dhiman Chowdhury\*,  
Mohammad Zakaria Haider, Mrinmoy Sarkar,  
Mustakim Refat, Kanak Datta and  
Shaikh Anowarul Fattah

Department of Electrical and Electronic Engineering,  
Bangladesh University of Engineering and Technology,  
Dhaka, Bangladesh

Email: dnchy0909@gmail.com

Email: zakariahaider14@gmail.com

Email: mrinmoy.pol@gmail.com

Email: mustakim.refat@gmail.com

Email: kanakeee08@gmail.com

Email: fattah@eee.buet.ac.bd

\*Corresponding author

**Abstract:** Braille printers are the most convenient way to emboss the texts on a Braille paper. But existing embossers are multiple times more expensive than the normal printers. In this paper, an innovative design of a low cost Braille printer is presented. The design being not dependent on expensive tools is an efficient solution. In the proposed Braille system, major concentration is given to develop the actuators which emboss the impressions on the Braille paper to make dots to decode text language in Braille format. Unlike conventional mechanisms, gear DC motors are utilised to design efficient and inexpensive actuators. Additionally, the overall printing system involves cost efficiently designed inter-dependent components, such as customised printing software, wireless communication system, sensing mechanisms, and compact mechanical setup. Extensive testing under different conditions is carried out and it is found that the proposed design can provide satisfactory embossing performance at a very low cost.

**Keywords:** actuator; Braille; communication; cost effectiveness; efficient; embosser; intuitive; printer; sensor; software; visually impaired.

**Reference** to this paper should be made as follows: Chowdhury, D., Haider, M.Z., Sarkar, M., Refat, M., Datta, K. and Fattah, S.A. (2018) 'An intuitive approach to innovate a low cost Braille embosser', *Int. J. Instrumentation Technology*, Vol. 2, No. 1, pp.1–17.

**Biographical notes:** Dhiman Chowdhury completed his graduation in Electrical and Electronic Engineering (EEE) from Bangladesh University of Engineering and Technology. He is currently executing some research works on power electronics, robotics and signal processing. He is also interested in learning machine design.

Mohammad Zakaria Haider completed his graduation in Electrical and Electronic Engineering (EEE) from Bangladesh University of Engineering and Technology. He is currently working on embedded system design and robotics applications. He is interested in entrepreneurship in robotics.

Mrinmoy Sarkar completed his graduation in Electrical and Electronic Engineering (EEE) from Bangladesh University of Engineering and Technology. He is thoroughly interested in computer vision and software development. He is now executing research activities on robotics, VLSI and signal processing.

Mustakim Refat completed his graduation in Electrical and Electronic Engineering (EEE) from Bangladesh University of Engineering and Technology. He is very interested in machine design and automation.

Kanak Datta completed his graduation in Electrical and Electronic Engineering (EEE) from Bangladesh University of Engineering and Technology and currently he is serving as a Lecturer in the same institute. He is very passionate for VLSI and device theories. He always tries to impart his knowledge among the students and fellow juniors.

Shaikh Anowarul Fattah received his PhD in ECE from Concordia University, Canada in 2008. He was a visiting Post-Doctoral Fellow and later a Visiting Research Associate in the Department of Electrical Engineering at Princeton University, New Jersey, USA. He received his BSc and MSc from BUET, Dhaka, Bangladesh, where he is currently serving as a Professor in the Department of EEE. He is interested in robotics, automation, signal processing and control system design and is currently conducting several research works on the respective subjects.

---

## 1 Introduction

Visually impaired (VI) persons are often subjected to sympathy and prejudice in the society where there is a little scope for them to be educated. Among different associative tools available for teaching the VI students, Braille printers are still the most pragmatic solution for their education. Braille embossers provide written format of books for the VI students. These printers provide impact printing to emboss the texts on a Braille paper using universal Braille codes and so provide written format of books. The Standard Perkins Braille printer has been the leading mechanical device since it was released to market in 1951 (Jenkins, 2012). Perkins also produced electric Perkins Brailler and large cell electric Braillers. Several software solution prototypes (Mennens et al., 1994; Wong et al., 2004; Blenkhorn and Evans, 2001) have been developed to optically recognise characters from documents and the output is sent to an electrical Braille embosser. But there lay problem with the availability of Braille embossers at a reasonably low price for frequent use. Typically such a machine costs from \$1,800 to \$5,000 and in case of large volume printer, it may cost more than \$10,000.

Several distinctive approaches have been practiced for designing efficient Braille embossers. In the design reported in Moore and Murray (2001), vertical scrolling of the embossing tool is used where the rotation is controlled by three stepper motors. In Li et al. (2011), a graphic printing method is introduced utilising zooming-edge detection and contour utilisation. There are some Braille embossers which can be operated using voice command (Sonawane and Gandhe, 2013). Among other techniques, method reported in Kociolek et al. (1999) utilises thermoplastic sheets and that in Silva et al. (2013) employs reverse engineering. In most of the cases, the cost of the Braille machine

becomes very high. A low cost multi-lingual Braille system output device with audio enhancement is proposed in Owayjan et al. (2013). Another prototype of Braille writing tutor is proposed in Kalra et al. (2009) with a view to combat illiteracy. An approach to translate a multifaceted script like Gujarati text along with English and Hindi text into Braille format is reported in Jariwala and Patel (2015). The paper presented in Damit et al. (2014) proposes a pathway to interlink and translate inputs from keyboard into Braille characters automatically in order to facilitate the visually challenged people a real time interaction with the visually sound people.

The work presented in Yin et al. (2010) introduces a paper-mediated Braille automatic recognition method which converts the scanned Braille images into corresponding binary images and then extracts the Braille features. The paper reported in Dharme and Karmore (2015) proposes an efficient method for the blind people to read digital electronic documents like e-books and e-texts in English Braille language. The paper documented in Sarkar et al. (2013) introduces a communication channel for the deaf blind and VI people which consists of three different subsystems to improve the communication skills of the visually handicapped persons. The proposed system contains a portable body-Braille display, an easy Braille writer and a remote communication system through SMS. An approach to develop a user friendly and cost effective mobile phone is reported in Iqbal et al. (2014) which helps visually challenged people make phone calls, save numbers and easily feel the display.

With the advancement of printing technology, the price of day to day life printers decreases significantly and it is now affordable to a large group of users. However, existing Braille embossers cost more than 100 times higher than that of normal printers which hinders its availability for individual utilisation. Hence, development of low cost Braille printer with satisfactory performance is still in great demand.

In this paper, a new and innovative design of a Braille printer is introduced with a target to offer very low production cost without sacrificing the overall quality. The prime focus is to substantiate a design of a three-dot Braille system which is not dependent on sophisticated and expensive tools but as productive and efficient as the complex and costly printers.

Three major sectors of the proposed design, namely hardware, software and communication system are presented in detail. A major contribution of this paper lies in the hardware design where unlike conventional methods, gear DC motor-based linear actuators are used and a very light and compact mechanical setup is constructed. On the other hand self-contained printing software is developed which can map Braille codes and can handle different file formats. For the purpose of communication, different types of sensors are effectively used in conjunction with wireless communication via Bluetooth modules. Implementation details and some experimental results with comparative feature analysis are presented to show the effectiveness of the proposed design.

## **2 Proposed design and implementation**

In the development of the proposed Braille printer, most widely used six dot Braille coding system is adopted where the raised dots are arranged in a grid with two dots horizontally and three dots vertically. The proposed design is divided into three major sectors:

- 1 hardware design
- 2 communication system design
- 3 software design.

In what follows, detail description of these three inter-dependent operational segments is presented.

### 2.1 *Hardware design and implementation*

In Figure 1, the proposed design of a cost effective Braille printing machine is presented. The proposed mechanical design contains six linear actuators, set-up box containing a printed circuit board (PCB), a channel made of two parallel iron rods, a wheel to turn pages forward and another two wheels for the consistent horizontal movement of the actuators along the channel. In Figure 2 different distinctive components of the proposed design is shown. It is to be mentioned that the two wheels placed face to face on the opposite side of each other are entangled by a thread to pull the actuators along with the setup box. Linear actuators emboss the impressions on the Braille paper to make dots to decode text language in Braille format. Set-up box, made of Plexiglas, controls the function of actuators. Wood plastic has been used as the base of the entire mechanical body.

The most promising and noteworthy feature of the proposed design is the self-customised methodology to develop and utilise substantive models of linear actuators. In Figure 3, the front view of the proposed linear actuator is shown for clear visualisation. The linear actuators have been made by using small gear motors rated 9 V, 200 rpm (revolution per minute) base speed, screws, nuts and sheathed iron blocks (these have been drilled to give them a perfect shape).

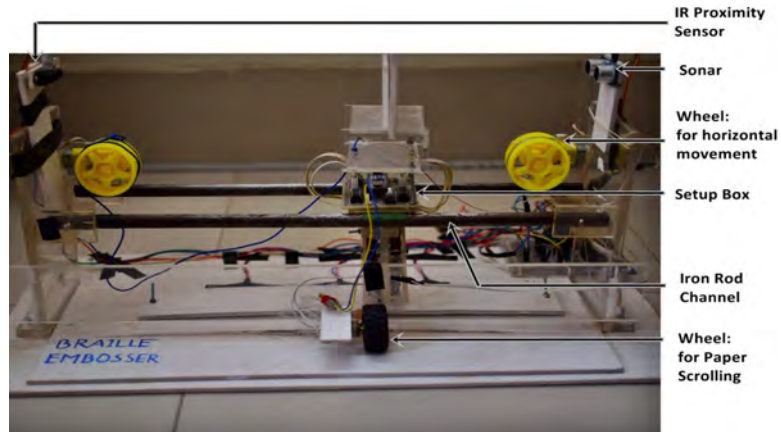
**Figure 1** Overall view of the complete package of the proposed machine, (a) necessary hardware (b) software interfacing using laptop (see online version for colours)



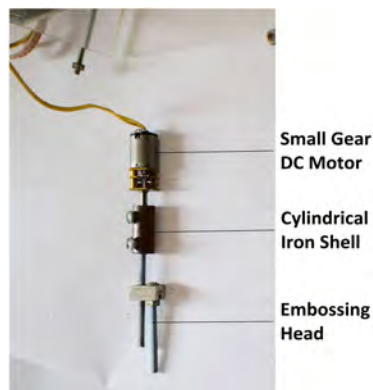
(a)

(b)

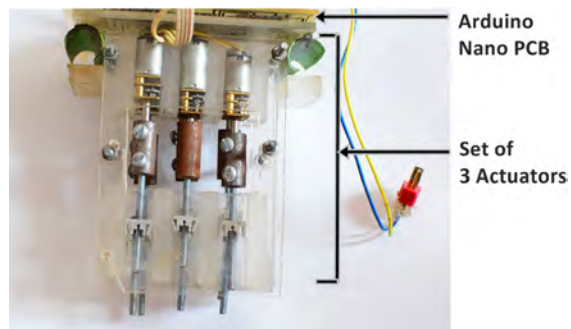
**Figure 2** The mechanical segment of the machine with its distinctive components (see online version for colours)



**Figure 3** Front view of the proposed linear actuator (see online version for colours)



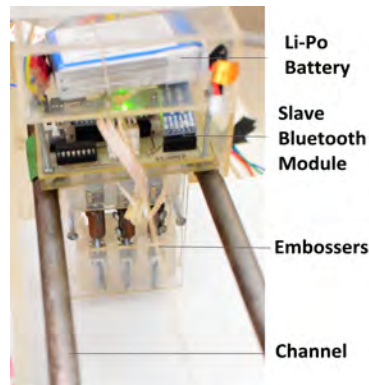
**Figure 4** Single sided view of the actuators' set (see online version for colours)



The embossing heads are the long screws standing beneath the enclosed cylindrical iron blocks which are attached to the shafts of the gear motors. The separation between two adjacent embossers is about 0.8 cm. The length of each embossing head is about 2 cm. The whole set of actuators is like a box of Plexiglas perpendicular to the printing surface. In Figure 4, the one sided view of the actuators' set is shown for better understanding. One major contribution is successful design of these efficient and inexpensive actuators which are different from the typical ones. The implicit fabrication of these actuators involves prevalence of intensive hardware design procedure and modelling of an apparent mechanical structure. In addition, the specification has been characterised upon computational framework and iterative mathematical calibration. In order to accommodate the inherent parts of the embossing tool, the basic manipulation of welding and shielding techniques has been applied and core knowledge of parametric modelling has been improvised.

In order to operate the printing setup according to the users instruction, a hardware segment is fabricated that incorporates different electric circuitries as well as simple breadboard and power supply (two 11.1 volts Li-Po batteries). An Arduino mega 2560 is utilised to control motor drivers which ensure the precise speed of three outer DC motors. In the proposed design gear DC motors are used to provide high torque in operation. An Arduino nano is used to control the operation of actuators via motor drivers. Figure 5 presents a perpendicular view of the Arduino nano with actuators navigating along the horizontal channel.

**Figure 5** Perpendicular view of the Arduino nano with actuators navigating along the horizontal channel (see online version for colours)



## 2.2 *Communication and sensor unit*

In order to establish wireless serial communication, the master-slave operation of two Bluetooth modules-HC-05 are employed. The master Bluetooth sends commands to its slave which controls the motion of the specific actuators according to the printing instructions. The sonar sensor is used to detect the distance of the actuator box while printing Braille alphabets or cells continuously. It works on the basis of sound reflection theory to measure the distance. It is applied with a view to locate the position of the actuator box precisely. The IR proximity sensor is placed on the opposite edge of the sonar which also locates the position of the cartridge specifically. This sensor functions on the basis of light reflection concept. There are three force resistive sensors (pressure

sensors) beneath the printing platform to ensure adequate impulsive force and realisable indentations of dots on the Braille paper. However a TFT display (QDtech) shows the text letters and corresponding Braille symbols in dots consequently for specification.

### 2.3 Software development

A completely new software namely Braille Printer is developed to transfer three types of file for printing purpose: .txt (text file), .pdf (portable document file) and .docx (word document file). This software is developed in Microsoft C#. The Braille printer software contains edit tools, mapping of Braille codes and help option to make it a complete package. This software incorporates 63 combinations of the universal Braille prototype. The entire program to execute the system operation is written in Arduino platform consisting of several code snippets and functional libraries. The developed software initiates the printing mechanism by taking input from the computer. Then processing of the input data is executed and data are sent to the Arduino board for embossing relevant Braille dots. Data input and processing are shown in Algorithm 1.

#### Algorithm 1 Data input and processing

---

Temporary variable  $\rightarrow temp$   
 Frame of data  $\rightarrow X$   
 Table of ASCII characters  $\rightarrow Y$   
 Length of the frame  $\rightarrow L$   
 Acknowledge character  $\rightarrow A$   
 Terminate character  $\rightarrow T$   
 Dummy variables  $\rightarrow I, J$   
**START:**  
 Load  $X \leftarrow$  first frame  
**Loop 1:**  
**for**  $J \leftarrow 0; J < L; J \leftarrow J + 1$  **do**  
      $temp \leftarrow X[J]$   
      $Y[temp] \rightarrow$  SEND  
**end for**  
 $T \rightarrow$  SEND  
 $temp \leftarrow receive$   
**Loop 2:**  
**if** ( $temp == A$ ) **then**  
     Load  $X \leftarrow$  next frame  
     **if** ( $X ==$  empty) **then**  
         STOP  
     **else**  
         GOTO Loop 1  
     **end if**  
**else**  
      $temp \leftarrow receive$   
     GOTO Loop 2  
**end if**

---

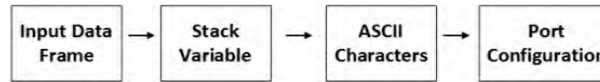
### 3 Description of the overall printing operation

The printing cycle starts with the software intended to upload and process the required data to be printed as any of .txt or .pdf or .docx format. In this iterative process, firstly the entire frame of printable data is stored in a variable of a certain length. Then this frame is mapped into a temporary stack variable which is indexed into a table of ASCII characters.

The mapped character is checked if it is recognisable or not. If the processed character is not worthy of imprinting, the data processing algorithm reiterates itself unless there is a valid character to proceed embossing. After ensuring the validity of the processed data, there is a confirmation message in the console of the developed software. This entity is necessary for processing next frame of data.

The algorithmic approach for input data processing is presented in Figure 6.

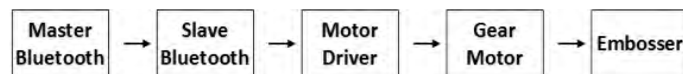
**Figure 6** Algorithmic approach for input data processing



The user has to configure port to send the specific data to the master Bluetooth module via Arduino mega. In this chain, command is passed to the slave Bluetooth to execute operation of actuators to make dotted impressions on a Braille paper. The linear actuators are customised in this proposed work and these are made of enclosed iron shells, properly sheathed and shaped. The actuation process is controlled by gear DC motors, which are operated according to the command execution of slave Bluetooth. Upon carrying out the printing command, the slave Bluetooth is programmed to activate the gear motors so that the embosser can imprint the text on a Braille paper in Braille format. The embossing heads of the cartridge create dotted impressions on the paper and these dots are considered Braille text for a visually challenged person. The indented dots have to be realisable while touching them, in this respect a force resistive sensor, popularly known as Pressure sensor, is placed beneath the printing surface.

The activation of gear motors attached to the actuator set is executed in accordance with the accurate transformation of inputted text into its Braille counterpart. There are six embossing heads to generate respective six dot Braille codes. Therefore, the activation of correct embosser is necessary for printing the relevant character in terms of its Braille interpretation. As an instance, the alphabet *B* is interpreted as the first two vertical dots of the first column of a Braille cell. Hence, to emboss *B* on a Braille paper, the motors attached to the first two vertical embossing heads of the actuator set are activated by the slave Bluetooth. To ensure the activation of correct combination of embossers, a map of Braille alphabets is included in the customised software. After the transformation of printing command from the master to the slave Bluetooth, the power is triggered-on of the relevant motors of the actuator by the slave module. There is a motor driver set embedded into an Arduino nano board for this activation process.

**Figure 7** Activation process flow of a specific embossing tool





The activation process of a particular embosser for printing the respective Braille text is presented in Figure 7.

While embossing a dot, the master Bluetooth does not send any further signal of command to its slave until the Pressure sensors beneath the embossing surface measure a required extent of pressure which ensures that there has been a realisable dotted emboss for the reader. When a dot is successfully indented, the actuators motors rotate otherwise to move the embossing head upward. If a letter requires more than one dot, the above process of embossing would continue unless all the required number of dots is indented to imprint the letter. Then two motors rotate along the rod channel to move the cartridge towards right with approximate (about 2 cm) line spacing and again the chain of command begins for the next letter and the process goes on. When one line is printed, the motor lying on the printing surface starts to rotate and makes the paper move forward for the next line to be printed. At the same time, the thread connected between the two upper wheels pull back the cartridge to its leftmost side to start from the initial point. Thus the whole process goes on to print consecutive words along several lines. The overall printing operation has been presented in Algorithm 2.

**Algorithm 2** Printing operation

---

```

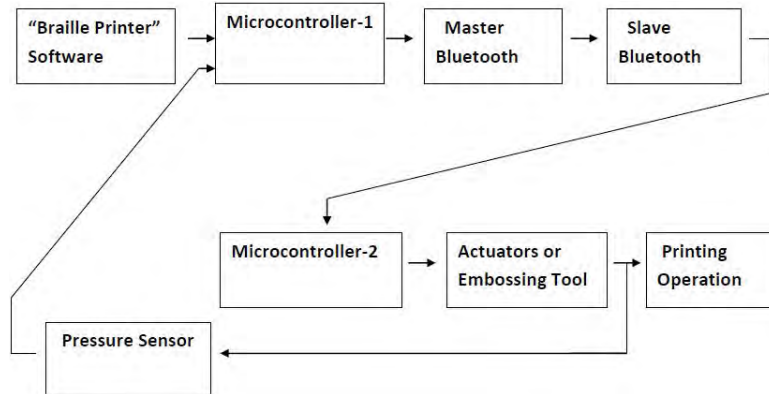
Motors array  $\rightarrow M$ 
Array of input data  $\rightarrow X$ 
Length of array  $\rightarrow L$ 
Acknowledge character  $\rightarrow A$ 
Terminate character  $\rightarrow T$ 
Dummy variables  $\rightarrow I, J$ 
START:
for  $J \leftarrow 0; J < L; J \leftarrow J + 1$  do
     $X[J] \leftarrow InputData$ 
end for
for  $J \leftarrow 0; J < L; J \leftarrow J + 1$  do
    if  $(X[J] = T)$  then
         $A \rightarrow SEND$ 
        STOP
    else
        for  $I \leftarrow 0; I < 6; I \leftarrow I + 1$  do
            if  $(X[J] \text{ SET } I)$  then
                Power on  $\rightarrow M[I]$ (forward direction)
                WAIT
                Power off  $!M[I]$ 
                Delay 50 ms
                Power on  $\rightarrow M[I]$ (reverse direction)
                WAIT
            end if
        end for
    end if
end for
end if
end for

```

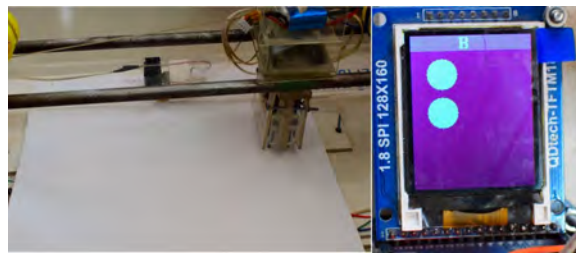
---

The entire process flow for printing a Braille coded alphabet is shown in Figure 8.

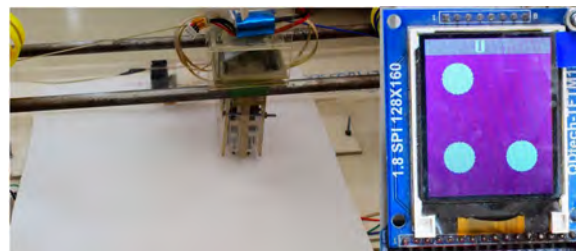
**Figure 8** Block diagram of the entire printing process of a Braille coded alphabet



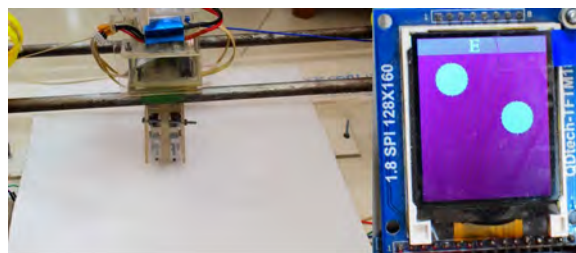
**Figure 9** The position of the cartridge while printing b in dots (left) and display showing the alphabet and dot representation (right) (see online version for colours)



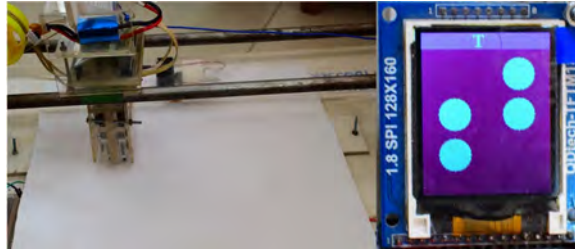
**Figure 10** Sequentially printing the alphabet u after printing b (see online version for colours)



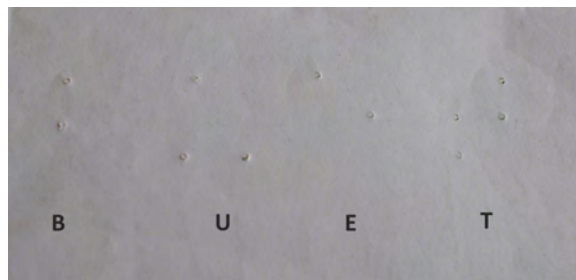
**Figure 11** Sequentially printing the alphabet e after printing u (see online version for colours)



**Figure 12** Sequentially printing the alphabet t after printing e (see online version for colours)

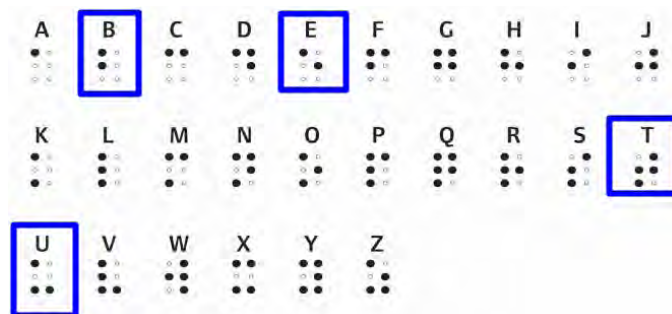


**Figure 13** The actual appearance of dots to transcribe BUET for the VI persons



In view of demonstrating the complete printing process, step by step snapshots are provided in Figures 9 to 3 for a sample case of printing the word BUET. In Figure 9, it is shown that the cartridge is at its leftmost position to start imprinting an array of the particular alphabets which starts with B. In a similar manner consequent alphabets will be printed. Combining the pictorial sequences, eventually the word BUET will be imprinted on the Braille paper. A map of Braille alphabets is shown in Figure 14.

**Figure 14** Map of Braille alphabets (see online version for colours)



#### 4 Result and analysis

The performance analysis of the proposed low cost Braille embosser features different caseworks and parametric evaluation. The demonstrated work has been tested for multiple times and the several indexes like cost effectiveness of the machine, precision of the embossed Braille codes, speed of the printing operation in case of a single alphabet,

single line and single page and also quality assessment in terms of noise, voltage, current and power fluctuations have been explored. In this follow-up, several casework analysis phenomena are briefly described here.

#### 4.1 Casework 1: cost analysis

The approximated cost for implementing the mechanical structure of the printing machine is \$150. The cost allocation with respect to the distinctive components is listed in Table 1. From a brief analysis upon commercial Braille printers, the current market prices of typical Braille printing modules are listed in Table 2. Here the testing machine is Romeo Attache Pro (including ET speaks and single sheet tractors). Braille and print together software to be analysed here is Transend SE and in order to study the commercial translation software package Duxbery Braille translator for windows is exemplified.

**Table 1** Allocated cost of the proposed design

<i>Components</i>	<i>Cost (\$)</i>
Ultra sonic sensor (sonar)	2.00
Infrared sensor(IR-proximity)	2.50
Wireless module (Bluetooth)	8.75
Microcontroller board-1 (Arduino mega)	15.00
Microcontroller board-2 (Arduino nano)	11.25
Arduino motor shield (driver set)	6.25
Printed circuit board (PCB)	7.00
DC power supply (Li-Po battery)	25.00
Printing module(Plexiglas structure)	18.75
Base structure	6.25
Embossing cartridge (containing actuators made of iron blocks and six small gear motors)	37.00
Two DC motors for horizontal heel operation	3.75
One small DC motor for scrolling operation	2.50
Three wheels	1.80
Wiring, shielding and others	2.50
Total	150.30

**Table 2** Optimised cost of the commercial Braille printers

<i>Available packages</i>	<i>Optimised minimum cost(\$)</i>
Single sided Braille printer	2,295
Double sided Braille printer	3,995
Commercial printing product	9,995
Braille printer software	400
Braille translation software	595

The speculative aspects affirm the fact that the proposed design is certainly a much less expensive Braille printing machine than the existing commercial ones. The axiomatically implemented Braille unit has incurred around 15 times less expense than those for the typical Braille writers.

The printing cost of the proposed machine is reasonable and has been experimentally evaluated almost 14 times less than those for the available industrialised Braille writers. The page wise printing cost comparison between the proposed printing machine and the commercial Braille writers is presented in Table 3.

**Table 3** Evaluated comparison among page wise printing expenses

<i>Elements</i>	<i>Cost(\$)/page for the commercial Braille writers</i>	<i>Cost(\$)/page for the proposed Braille writer</i>
In-state literary transcription	0.60	0.04
Out-of-state literary transcription	0.75	0.05
In-state text transcription	1.00	0.07
Out-of-state text transcription	2.00	0.14
Embossing on a 11 × 11: 5 sq: in. page	0.20	0.02
Large print (black and white) on a 11 × 14 sq: in. page	0.30	0.03

#### 4.2 Casework 2: speed analysis

The proposed Braille printing system has been tested for imprinting each of the registered alphabets, pneumatics and digits for more than 100 times for each sampling. And the test confirms that the average time taken by the machine for embossing each dot is approximately one second and eventually the average duration of printing a four-letter word like BUET is about 10 to 11 seconds. The average allocated time for embossing each segment of the word BUET is presented in Table 4.

**Table 4** Evaluated duration for embossing BUET

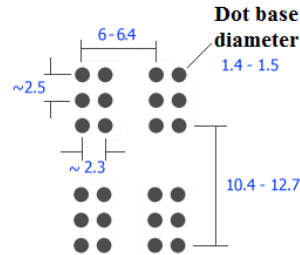
<i>Segments</i>	<i>Time (s)</i>
B	1.6
Space	0.3
U	2.5
Space	0.3
E	2.7
Space	0.3
T	3.2
Total	10.9

The performance index has been quite satisfactory in regard to the existing low speed (200 rpm) DC motors used for the actuating purpose. Subsequently, if higher torque with higher speed DC motors has been utilised instead of the former lower torque and cheap motors for implementing the design of actuators, the operational speed of the printing module would substantially increase invoking the time for embossing each dot within 0.5 second and for printing each alphabet within one second.

### 4.3 Casework 3: precision analysis

The proposed design has been tested for embossing different alphabets and pneumatics for several times. Each time experiment conveys that the font size of the imprinted Braille codes is relatively larger than the standard Braille size. This phenomenon is the consequence of the inconsiderable shape and structure of the customised actuators. In Figure 15, the standardised dimensions of Braille cells are shown whereas Table 5 lists the comparative prospects regarding the dimensions of the experimented Braille dots and of the universal Braille dots. Consequently, the observed result shows the Braille dots and cells embossed by The implemented cost effective Braille writer are almost 1.5–2 times larger in size compared to the standard format of the Braille codes. This discrepancy happens due to the limitation of actuating mechanism of the customised linear actuators which are unique and distinctive with respect to the design and mechanical formation. In addition, these actuators are the rudimentarily significant domains to make the proposed Braille a cost effective machine.

**Figure 15** Standard dimensions (mm) of Braille cells (see online version for colours)



**Table 5** Estimated dimensions of the imprinted Braille codes

<i>Parameter</i>	<i>Standard range (mm)</i>	<i>Experimented range (mm)</i>
Dot-base diameter	1.50–1.60	3.00–3.20
Distance between dots in the same cell	2.30–2.50	3.45–3.75
Distance between dots in the adjacent cells	6.10–7.60	12.20–15.20
Dot height	0.60–0.90	0.25–0.36
Distance between dots from one cell directly below	10.00–10.20	30.00–30.60

The font size problem may be subsided if the degree of cost reduction is taken into consideration. If more expensive and sophisticated actuators are used, the font size problem can easily be overcome. In this respect, further research work is in progress to reduce the font size without increasing the cost significantly.

### 4.4 Casework 4: noise and power quality analysis

Pertaining to the chronicles of the proposed system, experiments show that the machine is ecologically very friendly as no heat is dissipated to the surrounding during the operational period. The system is completely noise free; no vibration has been observed as well.

No electrical interference or impulsive discrepancy has occurred which compiles the fact of safety and sustainability of the developed system and its utilisation. Electrical quantities and phenomena like voltage surge, overload current, spikes and swelling of power signal and fluctuations of voltage and current have not been accompanied by this user friendly electromechanical Braille printing device and this accountability of the machine ratifies its stability.

#### 4.5 Casework 5: performance comparison with a commercial Brailier

Romeo Attache and Romeo Attache Pro Series are commercially exclusive Brailiers and the developers are arguably eminent in modification and advancement of Braille writing machines. The proposed Braille printer has been compared with one of the available commercial Braille embossers, referred to as Romeo Attache, with respect to performance evaluation and cost inspection. The demonstrated Braille embosser has been proven quite effective and sustainable through this comparative analysis against an industrialised Braille writer, especially in case of cost, speed and durability estimation. The contrast between a commercial package of Romeo Attache and the proposed Brailier is articulated in terms of a few performance indexes in Table 6.

**Table 6** Comparison between a commercial Brailier and the proposed machine

<i>Specification</i>	<i>Romeo Attache</i>	<i>Proposed Brailier</i>
Six or eight dot Braille	Both	Six dot
Speed	15 characters per second	one character per second
Printing cost per A4 size paper	1.7\$	0.12\$
Line width	32 characters per line	16–18 characters per line
Machine weight	Varies from medium to heavy weight	Light weight
Noise and vibration	Almost absent	Almost absent
Power quality	Excellent	Excellent
Durability	Long lifetime; needs frequent maintenance	long lifetime; does not need frequent maintenance

In accordance with the computed performance analysis of the developed Braille printer, it is certain that there is a scope of further advancement of this work especially in case of eradicating the problems of enlarged Braille dots and alphabets. In addition, the operating speed of the machine is apparently less than that of the industrialised Braille writers. To this solution, research and development activities are undergone to ensure the maximum stimulus from this machine.

The paramount factor in designing the Brailier is its cost effectiveness and a structure which is reliable, compact and free from power quality disturbances. The overall experimental assessment implies the novelty and sustainability of the proposed Braille printing module.

## 5 Conclusions

The paper presents an innovative but cost effective design of a Braille printing system which is affordable to a large group of VI people. Because of its low cost, like general printers available now a days, VI students can enjoy the benefit of frequent printing that will definitely help them getting better education. The proposed design of the Braille printing system consists of three major areas, namely hardware implementation, software development, and sensing and communication system design. In the hardware part, linear actuators are designed using gear DC motors and the overall structure of the mechanical setup is made light and compact. The software part introduces self-contained printing software which can map Braille codes and can handle different file formats. Finally a smart and effective sensing system is developed along with wireless communication via Bluetooth modules. Here different sensors are logically selected in order to measure distance, locate the position of the cartridge and to ensure adequate impulsive force. The cost of the proposed design ranges around \$150 which serves the main purpose of this research to develop a cheap and efficient Braille printer.

## References

- Blenkhorn, P. and Evans, G. (2001) 'Automated Braille production from word processed documents', *IEEE Trans. on Neural Systems and Rehabilitation Engineering*, March, Vol. 9, No. 1, pp.81–85.
- Damit, D.S.A., Ani, A.I.C., Muhamad, A.I., Abbas, M.H. and Ali, F.Z. (2014) 'Dual Braille code translator: basic education tool for visually impaired children', *Proc. IEEE 2014 Int. Conf. Computer, Communication and Control Technology (I4CT 2014)*, 2–4 September.
- Dharme, V.S. and Karmore, S. (2015) 'Designing of English text to Braille conversion system: a survey', *Proc. IEEE Sponsored 2nd Int. Conf. Innovations in Information Embedded and Communication Systems (ICIIECS15)*, 19–20 March.
- Iqbal, M.M., Balaji, L.P., Jayakar, M., Gokul, P., Kumar, R.K. and Jairam, R. (2014) 'Virtual simulation and embedded module of mobile phone using modified Braille display', *Proc. 2nd Int. Conf. Devices, Circuits and Systems (ICDCS)*, 6–8 March.
- Jariwala, N.B. and Patel, B. (2015) 'Transliteration of digital Gujarati text into printable Braille', *Proc. 5th Int. Conf. Communication Systems and Network Technologies*, 4–6 April.
- Jenkins, A.M. (2012) *Analysis of the Braille Writer Using Axiomatic Design*, PhD dissertation, Worcester Polytechnic Institute.
- Kalra, N., Lauwers, T., Dewey, D., Stepleton, T. and Dias, M. (2009) 'Design of a Braille writing tutor to combat illiteracy', *Information Systems Frontiers*, Vol. 11, No. 2, pp.117–128.
- Kociolek, M., Wiecek, B., De Mey, G., Steenkeste, F. and Muntenau, C. (1999) 'A Braille printer on reusable thermoplastic sheets', *Proc. EMBS. Conf.*, October, p.869.
- Li, B., Wang, Z., Liu, J. and Fang, G. (2011) 'New blind graphic printing technology based on new Braille printer', *Proc. CSSS. Conf.*, June, pp.1403–1406.
- Mennens, J., van Tichelen, L., Francois, G. and Engelen, J. (1994) 'Optical recognition of Braille writing using standard equipment', *IEEE Trans. on Rehabilitation Engineering*, December, Vol. 2, No. 4, pp.207–212.
- Moore, C. and Murray, I. (2001) 'An electronic design of a low cost Braille typewriter', *Intelligent Information Systems Conf. The Seventh Australian and New Zealand*, November, pp.153–157.
- Owayjan, E.D.M., Wehbe, T. and Ayoub, O. (2013) 'The design and development of a multi-lingual Braille system output device with audio enhancement', *Journal of Software Engineering and Applications*, Vol. 6, No. 6, pp.289–295.



- Sarkar, R., Das, S. and Rudrapal, D. (2013) 'A low cost microelectromechanical Braille for blind people to communicate with blind or deaf blind people through SMS subsystem', *Proc., 3rd IEEE Int. Advance Computing Conf. (IACC)*, 22–23 February.
- Silva, R., Moreira, R., Gouveia, L. and Felgueiras, M. (2013) 'Unblinding a Braille machine – a case study of reverse problem-based learning', *CISPEE Conf.*, October, pp.1–5.
- Sonawane, A.L.N. and Gandhe, S. (2013) 'Low cost Braille embosser using speech hypothesis', *Advances in Computing, Communication, and Control Conf.*, Vol. 361, pp.510–524, Springer Berlin Heidelberg.
- Wong, L., Abdulla, W. and Hussmann, S. (2004) 'A software algorithm prototype for optical recognition of embossed Braille', *Proc. 17th ICPR. Conf.*, August, Vol. 2, No. 3, pp.586–589.
- Yin, J., Wang, L. and Li, J. (2010) 'The research on paper-mediated Braille automatic recognition method', *Proc. 5th Int. Conf. Frontier of Computer Science and Technology (FCST)*, 18–22 August.